

2024 Parts Catalog

Index By Part

Page 1

COMMERCIAL DAMPER CONTROL SWITCHES	2
COMPONENT PARTS FOR COMMERCIAL DAMPER CONTROL SWITCHES	2
NAVY DAMPER CONTROL SWITCHES	3
COMPONENT PARTS FOR NAVY DAMPER CONTROL SWITCHES	3
NAVY BREAK GLASS STATION	4
NAVY BREAK GLASS STATION REPAIR KITS	4
DOOR HANDLES	4
GAYLORD WATER SOLENOID VALVES AFTER 2006	5
GAYLORD WATER SOLENOID COILS	5
GAYLORD WATER SOLENOID REPAIR KITS	5
GAYLORD WATER SOLENOID VALVES PRE 2006	6
GAYLORD WATER SOLENOID COILS PRE 2006	6
GAYLORD WATER SOLENOID VALVE NORMALLY OPEN	6
BALL VALVES	7
VACUUM BREAKERS	7
VACUUM BREAKER REPAIR KITS	7
WATER CHECK VALVES	7
BACKFLOW PREVENTERS	7
LINE STRAINERS	7
DETERGENT PUMPS	8
DETERGENT PUMP PARTS	8
PLUMBING CABINET PARTS	9
C-7000A COMPLETE CONTROLS	10
C-7000A CIRCUIT BOARD	10
C-6000C & C-6000D COMPLETE CONTROLS	10
C-6000D-ESP COMPLETE CONTROLS	10
GRC-5000 RETRO-FIT CONTROLS COMPLETE	10
C-6000B UPGRADE KITS	10
AUTOSTART & DCA SYSTEM COMPONENTS	11
OPERATOR INTERFACES	11
PLC'S	11
C-6000 CONTROL PARTS	11
C-200 CONTROL PARTS	12
C-100 CONTROL PARTS	12
AIRVANTAGE COMPONENTS	12
ELIMINATOR COMPONENTS	13
UV & UVI COMPONENTS	13-14
QUENCHER NOZZLES	15
QUENCHER LINE STRAINERS	15
HOOD PENETRATION FITTINGS	15
UV & UVI COMPONENTS	15
QUENCHER MODEL QUA COMPONENTS	16
QUENCHER MODEL QUS COMPONENTS	16
QUENCHER MODEL QU COMPONENTS	16
QUENCHER PLUMBING COMPONENTS	17
QUENCHER CHROME FITTINGS	17
GAS SOLENOID VALVES	18
GAS SOLENOID COILS	18
GAS SOLENOID REPAIR KITS	18
VENTILATOR COMPONENT PARTS	19
VENTILATOR SPRAY NOZZLES	19
VENTILATOR THERMOSTATS	20
VENTILATOR FUSE LINKS	20
MI CABLE	21
MI CABLE COMPONENTS	21
FIRE SWITCHES	21
FAST FOOD VENTILATOR PARTS	22
GX & GX2 EXTRACTOR CARTRIDGES	22
GREASE FILTERS	23
XG & XGS EXTRACTORS	23
HOOD LIGHTS	24
HOOD LAMPS	24
RSPC-ESP & RSPC-TPF COMPONENTS	25
RSPC FILTERS	26
RSPC FM-100 COMPONENTS	27
RSPC FM-1000 COMPONENTS	27
RSPC ODOR CONTROL PARTS	27
WASH CHEMICALS	27
MYLAR FACEPLATES & PORON DISCS	28
EXHAUST DAMPERS	28

COMMERCIAL DAMPER CONTROL SWITCHES

ALLOW 6-8 WEEKS FOR FABRICATION

PAGE 2

IMPORTANT NOTE: Damper Control Switches for "CG" Series Ventilators specify spring color in accordance with up to 6' red, up to 12' silver

up to 16' yellow DS hood length.

Blower Switch required on all GXB, 100, and 200 controls

Gaylord Part #	Description	
12671	C-61-L DAMPER CONTROL SWITCH – CG-BDL ELECTRIC DAMPER **	\$2,917.29
12680	C-61-GXS DAMPER CONTROL SWITCH – GX-AB & GX-CE ELECTRIC DAMPER	\$1,759.66
12703	C-61 CG DAMPER CONTROL WITH SWITCH (120 VOLT)	\$2,042.10
12679	C-61-GXB-RG DAMPER CONTROL SWITCH – RG FUSE LINK DAMPER	\$805.90
13036	C-61-GXSH DAMPER CONTROL SWITCH – GX-BDL ELECTRIC DAMPER (LEFT OR RIGHT) *	\$2,301.31
13220	C-61-GXB DAMPER CONTROL SWITCH – GX FUSE LINK DAMPER (LEFT OR RIGHT) *	\$1,126.31
17090	C-61-GXSH-RG DAMPER CONTROL SWITCH – RG-BDL ELECTRIC DAMPER	\$2,300.65
17091	C-61-GXS-RG DAMPER CONTROL SWITCH – RG-AB ELECTRIC DAMPER	\$1,675.88
18317	C-99-CG3 DAMPER CONTROL SWITCH – CG3 ELECTRIC DAMPER (24 VOLT includes sprocket)	\$4,239.12
20331	C-61-SH DAMPER CONTROL SWITCH*	\$2,130.85

*** SPECIFY EXTENSION LINKAGE LENGTH - 2", 6" OR 12" AND HANDLE LENGTH - 15", 18" OR 24"****** SPECIFY HANDLE LENGTH - 15", 18" OR 24"****COMPONENT PARTS FOR COMMERCIAL DAMPER CONTROL SWITCHES**

Gaylord Part #	Description	
10006	115 VOLT SOLENOID COIL FOR C-61	\$834.47
11328	220 VOLT SOLENOID COIL FOR C-61	\$192.22
18979	24V DAMPER ACTUATOR FOR CG3 WITH C-6000-B/C/D CONTROLS - MUST ORDER WITH PN 23367	\$3,057.87
23367	ACTUATOR MOUNTING EXTENSION - REQUIRED w/PN 18979	\$55.95
18449	C-99 GX2 DAMPER ACTUATOR 230V	\$3,185.01
19176	DAMPER ACTUATOR FOR CG3 OR GX2, WHEN USED WITH A C-6000 (24V)	\$2,853.06
22471	DAMPER ACTUATOR 120V FOR A GX2 (120V) **REPLACES PN 18451**	\$2,949.28
76284	DAMPER ACTUATOR ASSEMBLY KIT FOR CG3 WITH C-5000-99	\$2,921.82
19238	DAMPER ACTUATOR FOR CG3 WITH C-5000-99 - MUST ORDER WITH PN 22043-DAMPER SPROCKET	\$2,902.11
22043	C-5000-99 DAMPER SPROCKET - REQUIRED w/PN 19238	\$19.71
10012	7 X 9 LID FOR DAMPER CONTROL BOX	\$246.39
10023	LEFT SIDE LID GASKET 7" X 9" WITH PSA (PACKS OF 5)	\$48.11
18211	RIGHT SIDE LID GASKET 7" X 9" WITH PSA (PACKS OF 5)	\$52.92
10847	LEFT SIDE LID GASKET 7" X 13" WITH PSA (PACKS OF 5)	\$91.14
10848	RIGHT SIDE LID GASKET 7" X 13" WITH PSA (PACKS OF 5)	\$91.14
10022	LID SCREWS #8 PHILLIPS HEAD (PACK OF 100)	\$69.69
10011	L-HANDLE w/HARWARE INCLUDING RED BALL ***SPECIFY HANDLE LENGTH***	\$296.67
10021	SH-HANDLE w/HARDWARE INCLUDING RED BALL ***SPECIFY LINKAGE & HANDLE LENGTH***	\$649.75
10008	DAMPER ACTUATING ARM (DAMPER CONTROL TO DAMPER)	\$88.47
10010	BLOWER SWITCH	\$98.00

***SPECIFY HANDLE LENGTH - 15", 18", 24" OR 35"**

NAVY DAMPER CONTROL SWITCHES

IMPORTANT NOTE: Damper Control Switches for "CG" Series Ventilators specify spring color in accordance with up to 6' up 16' yellow DS hood length.

Gaylord Part #	Description	
12687	N-66 DAMPER CONTROL SWITCH 115V – NA, NAB, NC-TOP MT	\$1,649.37
12688	N-66-L DAMPER CONTROL SWITCH 115V – NBDL **	\$1,848.52
12689	N-66-R DAMPER CONTROL SWITCH 115V – NAD-SIDE MT	\$2,286.18
12690	N-66-E DAMPER CONTROL SWITCH 115V – NE-UNDER SHELF	\$2,174.53
16653	N-66-LDS DAMPER CONTROL SWITCH 115V – NBDL-DS **	\$1,710.27
12692	N-66-RE-S DAMPER CONTROL SWITCH 115V – NE-SIDE MT	\$1,995.23
13037	N-66-RE-T DAMPER CONTROL SWITCH 115V – NE-TOP MT	\$2,501.83
12693	N-66-SH DAMPER CONTROL SWITCH 115V – NBD *	\$2,183.52
18684	N-66/220 DAMPER CONTROL SWITCH 220V – NA, NAB, NC-TOP MT	\$2,084.29
18685	N-66-L/220 DAMPER CONTROL SWITCH 220V – NBDL **	\$2,277.90
18686	N-66-R/220 DAMPER CONTROL SWITCH 220V – NAD-SIDE MT	\$2,567.86
18687	N-66-E/220 DAMPER CONTROL SWITCH 220V – NE-UNDER SHELF	\$2,621.93
18688	N-66LDS/220 DAMPER CONTROL SWITCH 220V – NBDL-DS **	\$2,135.31
18689	N-66-RE-S/220 DAMPER CONTROL SWITCH 220V – NE-SIDE MT	\$2,438.92
18690	N-66-RE-T/220 DAMPER CONTROL SWITCH 220V – NE-TOP MT	\$2,398.61
18691	N-66-SH/220 DAMPER CONTROL SWITCH 220V – NBD *	\$2,254.79
12696	N-66/220 DAMPER CONTROL SWITCH 220V – NA, NB, NAB, NC-TOP MT	\$1,640.54
16802	N-66-RL/220 DAMPER CONTROL SWITCH 220V – NAD-SIDE MT/L HAND	\$2,213.74
16801	N-66-RE-S/220 DAMPER CONTROL SWITCH 220V – NE-SIDE MT	\$2,370.12
16800	N-66-SH/220 DAMPER CONTROL SWITCH 220V – NBD *	\$2,202.07
16799	N-66-G/220 DAMPER CONTROL SWITCH 220V – AUX EXH TERM	\$1,885.02
12695	N-68/440V DAMPER CONTROL SWITCH 440V – NA, NB, NAB, NC-TOP MT	\$3,794.99
12698	N-68-E DAMPER CONTROL SWITCH 440V – NE-UNDER SHELF	\$2,275.38

NAVY DAMPER CONTROL SWITCHES

12699	N-68-L/440V DAMPER CONTROL SWITCH 440V – NBDL **	\$2,461.54
12700	N-68-LDS DAMPER CONTROL SWITCH 440V – NBDL-DS **	\$2,328.13
12701	N-68-R/440V DAMPER CONTROL SWITCH 440V – NAD-SIDE MT	\$2,816.05
12691	N-68-RL/440V DAMPER CONTROL SWITCH 440V – NAD-SIDE MT/L HAND **	\$2,734.45
12708	N-68-RE-S DAMPER CONTROL SWITCH 440V – NE-SIDE MT	\$4,638.99
13198	N-68-RE-T/440V DAMPER CONTROL SWITCH 440V – NE-TOP MT	\$2,510.62
12702	N-68-SH/440V DAMPER CONTROL SWITCH 440V – NBD *	\$4,918.03
12705	N-68-G/440V DAMPER CONTROL SWITCH 440V – AUX EXH TERM	\$4,024.97
12706	N-68-NM/440V DAMPER CONTROL SWITCH 440V – NON-MAG	\$2,161.29
12697	N-68-B DAMPER CONTROL SWITCH WITH BLOWER SWITCH	\$2,334.52
16976	DAMPER CONTROL SWITCH N-97	\$5,222.01

***SPECIFY EXTENSION LINKAGE LENGTH - 2", 6" OR 12" AND/OR **HANDLE LENGTH - 15", 18" OR 24"**

COMPONENT PARTS FOR NAVY DAMPER CONTROL SWITCHES

Gaylord Part #	Description	
10023	LEFT SIDE LID GASKET 7" X 9" WITH PSA (PACKS OF 5)	\$52.92
18211	RIGHT SIDE LID GASKET 7" X 9" WITH PSA (PACKS OF 5)	\$52.92
10847	LEFT SIDE LID GASKET 7" X 13" WITH PSA (PACKS OF 5)	\$91.14
10848	RIGHT SIDE LID GASKET 7" X 13" WITH PSA (PACKS OF 5)	\$91.14
10008	DAMPER ACTUATING ARM (DAMPER CONTROL TO DAMPER)	\$97.32
12712	SOLENOID REPAIR KIT 115V - N66/N68 SRK	\$555.06
15628	SOLENOID REPAIR KIT 220V - N66 SRK	\$707.12
15625	SOLENOID REPAIR KIT 220V - N68 SRK	\$755.01
12713	SOLENOID REPAIR KIT 440V - N68 SRK	\$980.18

NAVY BREAK GLASS STATION

Gaylord Part #	Description	
17001	BREAK GLASS STATION 115 VOLT	\$4,453.33
12826	BREAK GLASS STATION 440 VOLT	\$4,453.33

NAVY BREAK GLASS STATION REPAIR KITS

Gaylord Part #	Description	
17028	REPAIR KIT FOR BREAK GLASS STATION 115 VOLT	\$2,274.62
12827	REPAIR KIT FOR BREAK GLASS STATION 440 VOLT	\$2,274.62
11039	440V RELAY FOR BREAK GLASS STATION	\$1,168.06
17050	SPARE GLASS AND BUTTON TACK FOR NDS-61-BG	\$500.52
15120	BREAK GLASS KIT INCLUDES SWITCH, HAMMER, REPLACEMENT GLASS INCLUDES: (6) GLASS DISKS & (1) BUTTON TACK	\$1,457.66

DOOR HANDLES FOR CONTROL CABINETS

75584	CHROME "T" DOOR HANDLE WITH TONGUE KIT	\$44.27
75585	CHROME LOCKING "T" DOOR HANDLE WITH TONGUE KIT	\$92.20
14953	FLUSH LATCH DOOR HANDLE WITH TONGUE KIT	\$150.82
11122	FLUSH LATCH LOCKING DOOR HANDLE WITH TONGUE KIT	\$219.34
75587	4" PULL HANDLE KIT FOR GX INSERTS (PACK OF 2)	\$53.44
20937	NAD HANDLE KIT	\$109.76

GAYLORD WATER SOLENOID VALVES FOR PRODUCT MANUFACTURED AFTER 2006 (GPC-6000C & D, GPC-7000, GRC-5000)

SOLENOID COIL IS NOT INCLUDED.

Gaylord Part #	Description	
12027	1/2" SOLENOID VALVE	\$413,45
12028	3/4" SOLENOID VALVE	\$482,49
12029	1" SOLENOID VALVE	\$1.858,75
12030	1 1/4" SOLENOID VALVE	\$2.124,20
12031	1 1/2" SOLENOID VALVE	\$2.444,13

GAYLORD WATER SOLENOID COILS FOR PRODUCT MANUFACTURED AFTER 2006 (GPC-6000C & D, GPC-7000, GRC-5000)

Gaylord Part #	Description	
12032	24 VOLT SOLENOID COIL 1/2" TO 3/4"	\$198,63
12033	120 VOLT SOLENOID COIL 1/2" TO 3/4"	\$202,78
12034	240 VOLT SOLENOID COIL 1/2" TO 3/4"	\$198,63
12035	24 VOLT SOLENOID COIL 1" TO 1 1/2"	\$136,33
12036	120 VOLT SOLENOID COIL 1" TO 1 1/2"	\$139,87
12037	240 VOLT SOLENOID COIL 1" TO 1 1/2"	\$140,06

GAYLORD WATER SOLENOID VALVE REPAIR KITS FOR PRODUCT MANUFACTURED AFTER 2006 (GPC-6000C & D, GPC-7000, GRC-5000)

Gaylord Part #	Description	
12038	1/2" VALVE REPAIR KIT	\$1.015,47
12039	3/4" VALVE REPAIR KIT	\$577,77
12041	1" - 1 1/4" VALVE REPAIR KIT	\$925,63
12042	1 1/2" VALVE REPAIR KIT	\$2.436,75

GAYLORD WATER SOLENOID VALVES - SLOW CLOSE - FOR GPC-4000, GPC-5000, C-6000, & GRC-5000 CONTROL

Gaylord Part #	Description	
10142	3/4" GAYLORD SOLENOID VALVE SLOW CLOSE	\$903,32
10143	1" GAYLORD SOLENOID VALVE SLOW CLOSE	\$2.814,19
10144	1 1/4" GAYLORD SOLENOID VALVE SLOW CLOSE	\$3.360,09
10140	1 1/2" GAYLORD SOLENOID VALVE SLOW CLOSE	\$4.618,43
15304	2" GAYLORD SOLENOID VALVE SLOW CLOSE	\$3.014,13

SLOW CLOSE SOLENOID VALVE REPAIR KITS FOR EQUIPMENT MANUFACTURED BEFORE 2006

Gaylord Part #	Description	
14387	1/2" GAYLORD SOLENOID VALVE REPAIR KIT	\$1.378,40
14388	3/4" GAYLORD SOLENOID VALVE REPAIR KIT	\$812,11
14389	1" GAYLORD SOLENOID VALVE REPAIR KIT	\$1.670,06
14390	1 1/4" GAYLORD SOLENOID VALVE REPAIR KIT	\$2.042,30
14391	1 1/2" GAYLORD SOLENOID VALVE REPAIR KIT	\$2.725,26

WATER SOLENOID VALVES - STANDARD CLOSE - FOR GPC-100, 200, 3000 SERIES CONTROL CABINETS MANUFACTURED BEFORE 2006

Gaylord Part #	Description	
10135	1/2" GAYLORD SOLENOID VALVE NORM CLOSED	\$518,41
10132	1" GAYLORD SOLENOID VALVE NORM CLOSED	\$1.249,76
10138	1 1/4" GAYLORD SOLENOID VALVE NORM CLOSED	\$1.567,99
10131	1 1/2" GAYLORD SOLENOID VALVE NORM CLOSED	\$3.450,40

STANDARD CLOSE SOLENOID VALVE REPAIR KITS FOR EQUIPMENT MANUFACTURED BEFORE 2006

Gaylord Part #	Description	
10122	1/2" GAYLORD STANDARD CLOSE WATER SOLENOID VALVE REPAIR KIT	\$643,08
10123	3/4" GAYLORD STANDARD CLOSE WATER SOLENOID VALVE REPAIR KIT	\$504,04
10124	1" - 1 1/4" GAYLORD STANDARD CLOSE WATER SOLENOID VALVE REPAIR KIT	\$773,36
10125	1 1/2" GAYLORD STANDARD CLOSE WATER SOLENOID VALVE REPAIR KIT	\$917,05

COILS FOR WATER SOLENOID VALVES FOR EQUIPMENT MANUFACTURED BEFORE 2006

Gaylord Part #	Description	
10156	120V REPLACE COIL FOR GAYLORD WATER SOLENOID (G SERIES)	\$575,12
10157	240V REPLACE COIL FOR GAYLORD WATER SOLENOID (G SERIES)	\$504,03

WATER SOLENOID VALVE - NORMALLY OPEN - FOR FREEZE PROTECTION DRAIN OFF

Gaylord Part #	Description	
10128	1/2" GAYLORD SOLENOID VALVE NORM OPEN	\$1.178,81
10127	1" GAYLORD SOLENOID VALVE NORM OPEN	\$3.471,25
16284	1 1/4" GAYLORD SOLENOID VALVE NORM OPEN	\$2.130,90
16285	1 1/2" GAYLORD SOLENOID VALVE NORM OPEN	\$2.656,24

BALL VALVES

Gaylord Part #	Description	
11258	½" FMT THD BALL VALVES, BRONZE	\$43,78
11263	¾" FMT THD BALL VALVES, BRONZE	\$72,65
11255	1" FMT THD BALL VALVES, BRONZE	\$104,43
10167	1 ¼" FMT THD BALL VALVES, BRONZE	\$239,37
11256	1 ½" FMT THD BALL VALVES, BRONZE	\$553,30
11260	2" FMT THD BALL VALVES, BRONZE	\$938,04

VACUUM BREAKERS

Gaylord Part #	Description	
10177	½" V.B. (ANGLE)	\$492,57
10179	¾" V.B. (ANGLE)	\$580,46
10180	1" V.B. (ANGLE)	\$1.201,72
10181	1 ¼" V.B. (ANGLE)	\$1.077,30
10182	1 ½" V.B. (ANGLE)	\$1.508,86
10183	2" V.B. (ANGLE)	\$5.122,60

VACUUM BREAKER REPAIR KITS

Gaylord Part #	Description	
10178	½" V.B. REPAIR KIT	\$137,67
10184	¾" V.B. REPAIR KIT	\$258,31
10185	1" V.B. REPAIR KIT	\$136,90
10186	1 ¼" V.B. REPAIR KIT	\$332,93
10187	1 ½" V.B. REPAIR KIT	\$896,97

WATER CHECK VALVES

Gaylord Part #	Description	
10195	½" WATER CHECK VALVE	\$346,88
10196	¾" WATER CHECK VALVE	\$381,84
10197	1" WATER CHECK VALVE	\$733,25
10198	1 ¼" WATER CHECK VALVE	\$1.547,67
10199	1 ½" WATER CHECK VALVE	\$917,73

BACKFLOW PREVENTERS

Gaylord Part #	Description	
11317	¾" BACKFLOW PREVENTER	\$2.794,56
11320	1" BACKFLOW PREVENTER	\$3.085,12
11319	1 ¼" BACKFLOW PREVENTER	\$5.002,51
11318	1 ½" BACKFLOW PREVENTER	\$5.226,36

BRASS LINE STRAINERS-FOR ALL WASH HOODS

Gaylord Part #	Description	
18114	½" LINE STRAINER	\$212,54
17138	¾" LINE STRAINER	\$202,49
17139	1" LINE STRAINER	\$278,54
17140	1 ¼" LINE STRAINER	\$538,19
18115	1 ½" LINE STRAINER	\$614,98

DETERGENT PUMPS FOR ALL MODELS OF CONTROL CABINETS

Gaylord Part #	Description	
10222	120V DETERGENT PUMP w/BRASS OUTLET	\$1,615.52
10223	220V DETERGENT PUMP	\$1,489.66
24206	120V DETERGENT PUMP w/PLASTIC OUTLET	\$1,615.52

DETERGENT PUMP PARTS - *ITEM NOT STOCKED, ALLOW TWO WEEKS FOR DELIVERY

Gaylord Part #	Description	
10231	ARMATURE BEARING	\$104.69
10232	MOTOR COIL 115V	\$276.95
10259	MOTOR COIL 220V	\$462.22
10233	ARMATURE	\$156.16
10234	ARMATURE SPACER (PACK OF 5)	\$39.42
10235	BRACKET	\$156.16
10236	SET SCREW (PACK OF 10)	\$40.92
10237	YOKE AND BEARING ASSEMBLY	\$106.88
10238	PUSH BUTTON TEST SWITCH	\$172.81
10239	BRACKET SCREW 10-32 X 3/8 (PACK OF 50)	\$28.86
10240	DIAPHRAGM	\$107.32
10242	BRASS OUTLET	\$43.59

DETERGENT PUMP PARTS - *ITEM NOT STOCKED, ALLOW TWO WEEKS FOR DELIVERY

10244	TOP CAP	\$28.58
10246	POPPET CHECK SPRING (PACK OF 5)	\$27.54
10247	PUMP HEAD COMPLETE WITHOUT DIAPHRAGM	\$331.36
10248	MOUNTING SCREW (PACK OF 5)	\$27.54
10250	POPPET CHECK (PACK OF 5)	\$28.47
10251	O-RING (PACK OF 10)	\$35.05
10253	GEAR BOX ASSEMBLY 60RPM	\$507.36
20466	ADJUSTABLE CAM 1-6	\$85.06
10254	CAM #1 FOR ½" PIPE	\$29.39
10255	CAM #2 FOR ¾" PIPE	\$27.54
10256	CAM #3 FOR 1" PIPE	\$27.54
10257	CAM #4 FOR 1 ¼" & 1 ½" PIPE	\$91.79

DETERGENT PUMP PARTS - *ITEM NOT STOCKED, ALLOW TWO WEEKS FOR DELIVERY

10260	INLET ADAPTER WITH O RING	\$27.54
10261	TUBE NUT FOR ¼" VINYL TUBING (PACK OF 5)	\$33.41
76826	BRASS DETERGENT CHECK VALVE 1/4FLR X 1/4FL (Replaces 10262)	\$180.25
76827	BRASS DETERGENT CHECK VALVE 3/8 X 3/8TB [PLASTIC TUBING] (Replaces 10263)	\$180.25
76829	BRASS DETERGENT CHECK VALVE ¼ FLR X 1/4 NPT (Replaces 10264)	\$180.25
76828	BRASS DETERGENT CHECK VALVE ¼ FLR X 3/8 FLR (Replaces 10265)	\$188.33

DETERGENT PUMP PARTS - *ITEM NOT STOCKED, ALLOW TWO WEEKS FOR DELIVERY

10266	INLET CHECK VALVE SPRING (PACK OF 5)	\$33.88
10268	TUBE NUT ¼	\$27.54
10269	FOOT VALVE	\$84.77
10271	ALLEN WRENCH 1/16	\$24.49
10272	VINYL TUBING ¼" (PER FOOT)	\$3.86
10273	COPPER TUBING ¼" (PER FOOT)	\$7.34
10275	PUMP HEAD AND FOOT VALVE KIT	\$534.85
15124	WEIGHT FOR DETERGENT PUMP VINYL TUBING	\$29.39

PLUMBING CABINET PARTS**Gaylord Part # Description**

10221	STAINLESS STEEL DETERGENT TANK (REPLACES PLASTIC DETERGENT TANK)	\$599,42
10175	PRESSURE TEMPERATURE GAUGE, 0-200 PSI, 70-320	\$376,45
10158	SHOCK ABSORBER FOR GPC-200 AND 3000 SERIES	\$112,99

PLUMBING PARTS FOR COLD WATER MIST**Gaylord Part # Description**

10135	½" SOLENOID VALVE NORM CLOSED	\$518,41
10924	½" WATER PRESSURE REDUCING VALVE	\$1.214,48
10276	PRESSURE GAUGE (RANGE 0-100 PSI)	\$95,30
10151	½" LINE STRAINER	\$50,26
11258	½" FMT THD BALL VALVE, BRONZE	\$43,78
10195	½" CHECK VALVE	\$340,41
10177	½" V.B.	\$499,32

PLUMBING CONTROL CABINETS**CONSULT FACTORY FOR PRICING ON ALL CONTROL CABINETS****AVAILABLE IN 120V AND 220V****ALLOW SIX WEEKS FOR FABRICATION**

MODEL C-7000 SERIES COMPLETE CONTROLS**FURNISHED COMPLETE MOUNTED ON CHASSIS - ALLOW 2 WEEKS FOR FABRICATION****NOTE: CONTROLS ARE STANDARD 120V; 220V IS OPTIONAL****MODEL C-7000B SERIES COMPLETE CONTROLS**

Gaylord Part #	Description	
20790	C-7000B S1-S4 **DOES NOT WORK w/ELECTRIC DAMPER MODULE, PN 76331**	\$11,481.37
20791	C-7000B S5-S10	\$12,079.92
20958	C-7000B S11-S16 w/UV/RSPC-ESP **ESP MODULE 22301 NOT INCLUDED**	\$13,743.33
20791	C-7000B-UVI-S0-S10 Control	\$12,079.92
22301	C-7000B ESP MODULE ASSEMBLY	\$3,861.78
22517	C-7000A & B CIRCUIT BOARD ONLY	\$2,781.31
76331	C-7000B ELECTRIC DAMPER MODULE **DOES NOT WORK w/C-7000 S1-S4, PN 20790**	\$1,044.36
18863	24VDC POWER SUPPLY NO BRACKET	\$360.38
76330	24v POWER SUPPLY with BRACKET	\$360.38
30876	220V OPTION FOR CONTROLS	\$3,271.12
76339	C-7000A TO C-7000B CONVERSION KIT	\$5,292.99

GPC Water Wash Complete Control Cabinets**FURNISHED COMPLETE WITH PLUMBING LOOP WASH SOLENOID(S) AND BACKFLOW PREVENTER ALLOW 6-8 WEEKS FOR FABRICATION****NOTE: CONTROLS ARE STANDARD 120V; 220V OPTION MUST BE PURCHASED SEPERATELY**

Gaylord Part #	Description	
76310	GPC-GRC-5000-S1-R.P.-0.75	\$18,570.43
76311	GPC-GRC-5000-S1-R.P.-1.00	\$18,570.43
76312	GPC-GRC-5000-S1-R.P.-1.25	\$18,570.43
76313	GPC-GRC-5000-S1-R.P.-1.50	\$18,570.43
76314	GPC-GRC-5000-S2-R.P.-0.75	\$19,109.94
76315	GPC-GRC-5000-S2-R.P.-1.00	\$19,109.94
76316	GPC-GRC-5000-S2-R.P.-1.25	\$19,109.94
76317	GPC-GRC-5000-S2-R.P.-1.50	\$19,109.94
76318	GPC-GRC-5000-S3-R.P.-0.75	\$19,649.45
76319	GPC-GRC-5000-S3-R.P.-1.00	\$19,649.45
76320	GPC-GRC-5000-S3-R.P.-1.25	\$19,649.45
76321	GPC-GRC-5000-S3-R.P.-1.50	\$19,649.45
76322	GPC-GRC-5000-S4-R.P.-0.75	\$20,188.97
76323	GPC-GRC-5000-S4-R.P.-1.00	\$20,188.97
76324	GPC-GRC-5000-S4-R.P.-1.25	\$20,188.97
76325	GPC-GRC-5000-S4-R.P.-1.50	\$20,188.97
76326	GPC-GRC-5000-S5-R.P.-0.75	\$20,728.48
76327	GPC-GRC-5000-S5-R.P.-1.00	\$20,728.48
76328	GPC-GRC-5000-S5-R.P.-1.25	\$20,728.48
76329	GPC-GRC-5000-S5-R.P.-1.50	\$20,188.97

GRC-5000 CONTROL**FURNISHED COMPLETE MOUNTED ON CHASSIS - ALLOW 6 WEEKS FOR FABRICATION****NOTE: CONTROLS ARE STANDARD 120V, 220V OPTION MUST BE PURCHASED SEPERATELY**

Gaylord Part #	Description	
30877	GRC-5000 STANDARD CONTROL	\$11,413.69
30878	GRC-5000 SEQUENTIAL CONTROL	\$12,963.69
19988	GRC-5000 J-BOX ***MEASUREMENTS: 11 1/2"L x 5"W x 3 1/2"D***	\$165.89
19984	GRC-5000 RETRO-FIT PLATE ***FOR USE WHEN REPLACING C-100 CONTROL ONLY***	\$108.23
23249	GRC-5000 RETRO-FIT CONTROL FOR C-5000-99 SYSTEMS	\$13,364.36
18863	24VDC POWER SUPPLY NO BRACKET	\$360.38
76330	24VDC POWER SUPPLY with BRACKET	\$360.38
30876	220V OPTION FOR CONTROLS	\$3,271.12
76340	GRC-5000 TO GRC-5000B CONVERSION KIT (FOR SINGLE SEQUENCE CONTROLS)	\$5,361.82
76341	GRC-5000 TO GRC-5000B CONVERSION KIT (FOR MULTI-SEQUENCE CONTROLS)	\$5,361.82

TSC/TST AUTO START SYSTEM

76017	TEMPERATURE SENSING CONTROL	\$1,709.70
76004	TEMPERATURE SENSING THERMOSTAT ASSEMBLY PRE-SET AT 90 DEGREE	\$840.37
20550	TEMPERATURE SENSING THERMOSTAT ASSEMBLY PRE-SET AT 280 DEGREE	\$840.37

DCA AUTO START SYSTEM

22271	DCAP PRIMARY CONTROL BOX	\$2,658.00
22272	DCAS SECONDARY CONTROL BOX	\$1,166.36
20318	DCA CONTROL BOARD	\$470.07
20319	DCA RTD ASSEMBLY W/1' CABLE	\$294.58

OPERATOR INTERFACE

Gaylord Part #	Description	
30879	OPERATOR INTERFACE FOR GRC-5000A and GRC-5000B	\$2,510.28
20527	OPERATOR INTERFACE FOR C-7000A	\$2,510.28
30880	PLC TO OPERATOR INTERFACE CABLE FOR GRC-5000A, C6000-ESP, C6000-C, C6000-D, AND C7000A	\$282.28
76338	OPERATOR INTERFACE CABLE FOR GRC-5000B	\$116.41
76337	OPERATOR INTERFACE FOR C-7000B	\$2,587.92

PROGRAMMABLE LOGIC CONTROLLER (PLC)

Gaylord Part #	Description	
76336	PLC FOR GRC-5000B (INCLUDES PROGRAM) FOR CONTROLS MANUFACTURED AFTER 1/1/22	\$3,586.12
76335	PLC FOR C-7000B (INCLUDES PROGRAM) FOR CONTROLS MANUFACTURED AFTER 1/1/22	\$3,264.80
23994	8 I/O EXPANSION MODULE FOR CONTROLS MANUFACTURED AFTER 1/1/22	\$1,046.21
22454	16 I/O EXPANSION MODULE FOR CONTROLS MANUFACTURED AFTER 1/1/22	\$1,208.75
23995	PLC BATTERY FOR CONTROLS SOLD AFTER 1/1/22	\$160.19
22453	PLC BATTERY FOR ORIGINAL PANASONIC PLC (WHITE)	\$124.40

C-6000 SERIES CONTROL PARTS

Gaylord Part #	Description	
18863	24VDC POWER SUPPLY	\$345.97
76330	24VDC POWER SUPPLY UPGRADE KIT **UPDATED BOARD IS SMALLER THEN ORIGINAL**	\$345.96
13062	FUSE (F1) - 2 AMP 24VDC POWER SUPPLY (pack of 5)	\$19.24
10039	FUSE (F2) - 4 AMP PLC 120 VAC (pack of 5)	\$19.24
19027	FUSE (F3) - 1AMP SUPPLY FAN MAG. STARTER (pack of 5)	\$35.46
19027	FUSE (F4) - 1 AMP EXHAUST FAN MAG STARTER (pack of 5)	\$35.46
13062	FUSE (F5) - 2 AMP (C-6000-10) TRANS. PRIMARY (pack of 5)	\$19.24
10039	FUSE (F5) - 4 AMP (C-6000-20) TRANS. PRIMARY (pack of 5)	\$19.24
19020	FUSE (F6) - 6 AMP TRANSFORMER SECONDARY	\$24.87
10039	FUSE (F7) - 4 AMP (UV CONTROLS) (pack of 5)	\$19.24
18980	FLASH GUARD (SPECIFY CONTROL)	\$105.32
18981	100 VA TRANSFORMER	\$367.50
18891	250 VA TRANSFORMER	\$973.10
10035	START SWITCH (TO USE WITH A C-6000B AND MARINE CONTROL)	\$56.80
18983	C-6000 OUTPUT MODULE	\$1,333.04
19319	SONALERT (UV CONTROL)	\$229.17
30375	TIMING RELAY (TR1, TR2 UV CONTROL)	\$424.96
19272	SOCKET 8-PIN FOR TIMING RELAY (UV CONTROL)	\$33.51
16892	LOW DETERGENT FLOW SWITCH	\$841.59
16893	1/8 PORT ADAPTER FOR FLOW SWITCH	\$58.50
10869	1/4 x 1/8 BRASS COMPRESSION ELBOW	\$3.20
10010	FIRE TEST SWITCH	\$98.00

MODEL C-200 & NC-200 SERIES CONTROL ELECTRICAL PARTS

Gaylord Part #	Description	
10280	AGASTAT SOCKET BASE	\$147,39
10049	AGASTAT SOLID STATE TIMER 115V - ADD JUMPER TERMINAL 6 TO TERMINAL 7	\$985,57
10050	AGASTAT SOLID STATE TIMER 220V	\$1,285,08
13039	FUSE HOLDER	\$25,17
10039	4 AMP 250V SMALL DIM FUSE (PACK OF 5)	\$19,24
10283	CONTROL RELAY R3	\$75,44
10295	DPDT RELAY SOCKET BASE	\$42,47
10051	OPERATOR BASE W/SHROUD	\$401,04
10052	AMBER "BY-PASS" LENS WITH "BY-PASS" INSCRIPTION DISK	\$34,46
10053	GREEN "START" LENS WITH "START" INSCRIPTION DISK	\$44,37
10054	RED "STOP" LENS WITH "STOP" INSCRIPTION DISK	\$38,72
10055	RED "RESET" LENS	\$43,07
10058	BLANK INSCRIPTION LENS ONLY (PACK OF 5)	\$39,95
10057	6V BULB	\$54,32
10056	115V BY-PASS SWITCH ASSEMBLY	\$379,79
75628	440V NAVY BY-PASS SWITCH ASSEMBLY	\$537,49
12770	115V COMMERCIAL STOP SWITCH ASSEMBLY	\$419,14
12771	115V COMMERCIAL START SWITCH ASSEMBLY	\$388,26
75627	440V NAVY STOP SWITCH ASSEMBLY	\$537,49
75626	440V NAVY START SWITCH ASSEMBLY	\$537,49
10059	N/C CONTACT BLOCK (STOP)	\$64,54
10060	N/O CON BLK/STOP, START, BY-PASS	\$56,83
10062	LAMP HOLDER (SHORT)	\$21,95
10064	TRANSFORMER 120V/6V	\$161,43
10066	TRANSFORMER 440V/6V	\$198,34
10093	TRANS 440/115V (NAVY CONTROL)	\$365,12
12768	LCS NORMAL OPERATION SWITCH	\$421,27

MODEL C-100 SERIES CONTROL ELECTRICAL PARTS

Gaylord Part #	Description	
10033	AGASTAT TIMER 10MI 115V	\$3,202,20
10072	AGASTAT TIMER 30MI 115V*	\$2,978,04
10069	AGASTAT SOCKET BASE*	\$26,18
13039	FUSE HOLDER	\$25,17
10032	(8) TERMINAL BLOCKS/1 END CAP*	\$76,81
10035	START SWITCH	\$56,80
10036	STOP SWITCH	\$120,30
10038	PUSH BUTTON OPERATOR FOR START & STOP	\$132,61
10283	DPDT RELAY 120V AC	\$75,44

* ITEM NOT STOCKED, ALLOW FOUR WEEKS FOR DELIVERY

AV - AIRVANTAGE COMPONENTS

Gaylord Part#	Description	
19871	120/240 24V 40VA Transformer	\$91,19
20319	DCA RTD ASSEMBLY W/1' CABLE	\$294,58
20382	RTD Connection Cable Only	\$66,32
23774	RTD	\$228,26
22279	DCV-AV or Button with Leads	\$162,63
22252	100% AV Bypass Button (Black)	\$83,43
21770	AV Damper Actuator	\$2,712,77
21771	0.25in WG Pressure Transducer	\$970,96
21772	0.50in WG Pressure Transducer	\$1,088,18
21773	1.0in WG Pressure Transducer	\$1,342,92
21774	2.0in WG Pressure Transducer	\$1,342,92
22248	Fan Board w/screen	\$3,348,75
22267	Hood Board	\$893,44
20825	100% Fan Button	\$158,46

ELIMINATOR COMPONENTS

Gaylord Part #	Description	
22894	Eliminator Ballast	\$2,051.66
23779	Eliminator UV Lamp	\$1,362.69
22789	Eliminator TDR Time Delay Relay	\$298.95
23360	Eliminator Grommet	\$9.34
76165	ESP Cell ELXC-SPC-SO	\$7,875.12
76177	UV Module ELXC-SPC	\$8,637.02
76201	Eliminator Soak Tank	\$2,098.25
76207	Eliminator Wiring Harness	\$1,235.15
19522	CG3 UV 16 PARTICULATE SEPARATOR (STANDARD) 7 5/8" X 15 1/2"	\$373.84
76042	18" XGS EXTRACTOR (ENLARGED)	\$269.84
76199	IONIZING WIRE - ELXC-SPC	\$102.60
23775	SMART RELAY WITH PROGRAM	\$905.10
23115	OPACITY TRANSMITTER BOARD W/OPTICS	\$1,923.25
23116	OPACITY RECEIVER BOARD W/OPTICS	\$1,923.25
23166	ELXC-SPC-ESP CELL POWER SUPPLY	\$5,296.14

RELAYS

Gaylord Part #	Description	
30827	SPDT 120VAC RELAY	\$34.51
30828	DPDT 120VAC RELAY	\$43.71
30829	TPDT 120VAC RELAY	\$57.77

UV MODULE PARTS

Gaylord Part #	Description	
23366	UV LIGHT GROMMET PACK OF 1 (REPLACES PART NUMBER 19312)	\$9.39
19296	UV LAMP 3 FOOT - BI-PIN	\$203.70
19301	UV LAMP 5 FOOT - BI-PIN	\$286.96
20269	UVi LAMP 3 FOOT - SINGLE PIN	\$203.71
20270	UVi LAMP 5 FOOT - SINGLE PIN	\$286.96
19313	UV LAMP HOLDER PACK OF 6	\$17.39
20271	LED UVI LAMP MONITORING BOARD	\$592.51
19799	UV LIGHT SOCKET SINGLE PIN	\$52.38

UV MODULE PARTS

Gaylord Part #	Description	
20140	1/4" BONDED WASHER PACK OF 10	\$17.91
19356	1/4"-20 X 2- 1/2" BOLT PACK OF 10	\$94.27
19358	1/4 RETAINING CLIP PACK OF 10	\$94.27
23424	UVI LIGHT BALLAST DUAL VOLTAGE FOR CG3, GX2, XG MODEL HOODS	\$1,968.78
19308	CIRCUIT BOARD STAND OFF (PACK OF 10)	\$17.39
18153	FUSE (F1) 500M AMP UV CONTROLLER (PACK OF 5)	\$18.78
75878	UV-3 GASKET KIT, INCLUDES: FRAME GASKET, LEFT & RIGHT CHASE GASKETS	\$381.73
75879	UV-5 GASKET KIT INCLUDES: FRAME GASKET, LEFT & RIGHT GASKETS FOR END CAPS	\$881.23
22472	UNIVERSAL UVI LIGHT BALLAST DUAL VOLTAGE ELX & ELXC	\$1,968.77
20993	CG3-UV HOOD TO MODULE HARNESS	\$25.87
20016	CG3/GX2 UV MODULE COOLING FAN	\$131.22

UV MODULES

Gaylord Part #	Description	
76057	ELX UVi-3 LIGHT MODULE (COMPLETE) INCLUDES UV LAMP HARNESS FRAME GASKETS	\$3,998.62
76058	ELX UVi-5 LIGHT MODULE (COMPLETE) INCLUDES UV LAMP HARNESS FRAME GASKETS	\$4,110.56
75876	UVi-3 LIGHT MODULE (COMPLETE) INCLUDES CONTROLLER BALLAST UV LAMP HARNESS FRAME GASKETS	\$13,084.24
75877	UVi-5 LIGHT MODULE (COMPLETE) INCLUDES CONTROLLER BALLAST UV LAMP HARNESS FRAME GASKETS	\$11,853.48

UV VENTILATOR PARTS

Gaylord Part #	Description	
76028	120volt UV MONITORING BOARD (CIRCUIT BOARD STYLE CONTROL)	\$3,225.76
76029	220volt UV MONITORING BOARD (CIRCUIT BOARD STYLE CONTROL)	\$3,225.76
20100	UV MONITORING CIRCUIT BOARD (DOES NOT INCLUDE CONTACTOR)	\$2,877.94
19794	UV GRAY DOOR GASKET STRIP (2 ROLLS FOR 3FT DOOR, 3 ROLLS FOR 4FT DOOR)	\$89.16
30529	CONTACTOR	\$411.12
11399	CONTROL RELAY-SPDT	\$63.36
11413	SOCKET SPDT	\$45.62
10283	CONTROL RELAY-DPDT	\$75.44
10295	SOCKET-DPDT	\$42.47
12512	INDICATOR LIGHT - GREEN	\$43.83
22692	LINE FILTER	\$558.15
22693	UV TIME DELAY RELAY (Replaces PN 11347)	\$46.59
11347	TIME DELAY RELAY (Replaced by PN 22693)	\$211.88
76087	HIGH TEMP SHUTDOWN KIT	\$525.10
22472	UNIVERSAL UVI LIGHT BALLAST DUAL VOLTAGE ELX & ELXC	\$1,968.77
76138	UV BALLAST PLATE INCLUDES 3 22472 BALLASTS AND WIRING HARNESS	\$6,048.45

UV VENTILATOR PARTS

Gaylord Part #	Description	
19162	INDICATOR LIGHT - YELLOW	\$33.86
12510	INDICATOR LIGHT - RED	\$26.79
19355	UV ACCESS DOOR SWITCH	\$19.34
19365	UV PRESSURE SWITCH FOR CG3, GX2, & XG MODEL VENTILATORS	\$305.09
20489	UV PRESSURE SWITCH FOR ELX & ELXC MODEL VENTILATORS	\$131.15
19350	STATIC PRESSURE SWITCH	\$78.46
19416	UV PROXIMITY SWITCH (CG3)	\$650.83
19725	ELX-UVi & ELXC-UVi STATUS LIGHT GREEN	\$89.61
19724	ELX-UVi & ELXC-UVi STATUS LIGHT AMBER	\$124.45
20766	ELX-UVi & ELXC-UVi STATUS LIGHT BLUE	\$89.61

UV VENTILATOR PARTS**NON STOCK ITEMS. ALLOW 3 WEEKS TO SHIP.**

19417	PROXIMITY SWITCH MAGNET (CG3)	\$216.01
16903	UV PLUG FEMALE	\$19.34
19430	COOLING FAN	\$189.05
19427	GX2-UV "GEM" EXTRACTOR MONITORING BOARD	\$1,318.27
19397	UV STATUS LABEL	\$79.63
19164	UV HOUR METER 120VOLT	\$487.41
20564	HOUR METER	\$827.50
21966	CR24 RELAY FOR CONVERTING 120V SIGNAL TO DRY CONTACT FOR USE WITH 19164	\$160.00

UV VENTILATOR PARTS

Gaylord Part #	Description	
19400	UV "CAUTION" LABEL	\$122,81
19353	GX2-UV-16-16" PARTICULATE SEPARATOR (STANDARD) 7 3/4" X 15 1/2"	\$254,90
19354	GX2-UV-20-20" PARTICULATE SEPARATOR (STANDARD) 7 3/4" X 19 1/2"	\$299,88
19380	GX2-UV-EN16-16" PARTICULATE SEPARATOR (ENLARGED) 8 7/16" X 15 1/2"	\$287,00
19381	GX2-UV-EN-20 -20" PARTICULATE SEPARATOR (ENLARGED) 8 7/16" X 19 1/2"	\$280,59
19522	CG3 UV 16 PARTICULATE SEPARATOR (STANDARD) 7 5/8" X 15 1/2"	\$373,84
19523	CG3 UV 20 PARTICULATE SEPARATOR (STANDARD) 7 5/8" X 19 1/2"	\$254,90
19451	CG3 UV EN 16 PARTICULATE SEPARATOR (ENLARGED) 11 1/2" x 15 1/2"	\$302,28
19452	CG3 UV EN 20 PARTICULATE SEPARATOR (ENLARGED) 11 1/2" x 19 1/2"	\$328,19

CUV-1000 CONTROL FOR NON-WATER WASH SYSTEMS

20109	CUV-1000 OPERATOR INTERFACE WITH PROGRAM	\$2,110,02
20108	CUV-1000 PLC WITH PROGRAM	\$1,889,20
20107	CUV-1000/FM-1000 CABLE	\$152,44

QUENCHER NOZZLES

Gaylord Part #	Description	
19046	DUAL TECH NOZZLES	\$5,107,00
75888	DUAL TECH BELL REDUCER NIPPLE KIT	\$34,15
QUENCHER FIRE PROTECTION CABINET		
*** CONSULT FACTORY FOR PRICING. ALLOW 3 WEEKS FOR FABRICATION ***		

QUENCHER NOZZLES - *NO DISCOUNTS APPLY*****

Gaylord Part #	Description	
10285	175 DEGREE WATER SPRAY NOZZLE (YELLOW)	\$1,502,67
10286	250 DEGREE WATER SPRAY NOZZLE (BLUE)	\$2,423,66
10287	325 DEGREE WATER SPRAY NOZZLE (PURPLE)	\$2,782,72
10289	500 DEGREE, 160° SPRAY ANGLE, 1/4" ORIFICE, BRONZE	\$2,415,08
10290	500 DEGREE, 95° SPRAY ANGLE WATER SPRAY NOZZLE, BRONZE	\$2,796,53
16401	325 DEGREE, 65° SPRAY ANGLE, 1/4" ORIFICE, BRONZE (DUCT)	\$1,492,96

QUENCHER NOZZLES - **NO DISCOUNTS APPLY******

Gaylord Part #	Description	
16402	325 DEGREE, 160° SPRAY ANGLE, 1/4" ORIFICE, BRONZE (PLENUM)	\$1,415,41
12832	NOZZLE WRENCH	\$29,74
10278	CHROME HEAD GUARD FOR NOZZLES	\$95,07

QUENCHER LINE STRAINERS

Gaylord Part #	Description	
10149	1" LINE STRAINER	\$90,92
10148	1 1/4" LINE STRAINER	\$115,19
10147	1 1/2" LINE STRAINER	\$142,22
10152	2" LINE STRAINER	\$650,60

QUENCHER HOOD PENETRATION FITTINGS

Gaylord Part #	Description	
11337	3/8" HOOD PENETRATION FITTING WITH LOCKNUT	\$56,07
11338	1/2" HOOD PENETRATION FITTING WITH LOCKNUT	\$230,00
11339	1/2" EMT HOOD PENETRATION FITTING WITH LOCKNUT	\$66,75
11340	1" HOOD PENETRATION FITTING WITH LOCKNUT	\$724,25

QUENCHER MODEL "QUA" ELECTRICAL COMPONENTS**NEW STYLE QUENCHER CONTROL**

Gaylord Part #	Description	
13178	QUENCHER TERMINAL BLOCK BOARD	\$703,93
12836	QUENCHER QUA COMPLETE CONTROL	\$5,393,04
11392	QUENCHER PC BOARD (NO BRACKET)	\$3,808,95
10039	4 AMP 250V SMALL DIM FUSE (PACK OF 5)	\$19,24
13179	FLASHGUARD FOR QUENCHER TERMINAL BLOCK BOARD	\$71,84
13181	MYLAR DOOR LABEL FOR QUA SERIES (VERTICAL)	\$114,93
15118	¼" X 7/8" OD PORON DISC W/ PSA (PACK OF 2)	\$37,75
11288	SPRING FOR QUENCHER (PACK OF 10)	\$16,94
10283	DPDT RELAY 120V	\$75,44
11403	3PDT RELAY 120V	\$142,53
19180	SPST MEMBRANE (FOR RESET BUTTON)	\$500,96

QUENCHER MODEL "QUS" SERIES ELECTRICAL COMPONENTS

Gaylord Part #	Description	
10039	4 AMP 250V SMALL DIM FUSE (PACK OF 10)	\$19,24
75328	QUS RETRO-FIT COMPLETE CONTROL (SPECIFY HORIZ OR VERT MOUNT)	\$5,393,04
50453	POWER INTERRUPTION DEVICE Includes time delay relay (Replacement battery is PN 24190)	\$3,489,48
24190	REPLACEMENT BATTERY for PN 50453	\$925,25
10854	QUENCHER BATTERY	\$126,22
10037	BY-PASS SWITCH	\$32,95

QUENCHER MODEL "QU" SERIES ELECTRICAL COMPONENTS

Gaylord Part #	Description	
12785	SYSTEM OPERATIONAL GREEN LIGHT	\$314,74
12783	SYSTEM NON OPERATIONAL AMBER LIGHT	\$351,30
12782	FIRE ALERT INDICATOR RED LIGHT	\$350,58
12784	RED RESET BUTTON	\$391,59
10051	OPERATOR BASE W/SHROUD	\$401,04
10052	AMBER "BY-PASS" LENS WITH "BY-PASS" INSCRIPTION DISK	\$34,46
10053	GREEN BLANK LENS WITH "START" INSCRIPTION DISK	\$44,37
10054	RED BLANK LENS WITH "STOP" INSCRIPTION DISK	\$38,72
10055	RED RESET LENS	\$43,07
10058	BLANK INSCRIPTION LENS ONLY (PACK OF 5)	\$39,95

QUENCHER MODEL "QU" ELECTRICAL COMPONENTS

Gaylord Part #	Description	
10057	6V BULB	\$54,32
10062	LAMP HOLDER (SHORT)	\$21,95
10064	TRANSFORMER 120V/6V	\$161,43
10283	DPDT RELAY 120V	\$75,44
10037	BY-PASS SWITCH	\$34,93
10295	DPDT RELAY SOCKET BASE	\$42,47
11403	3 PDT RELAY 120V	\$142,53

*** ITEM NOT STOCKED, ALLOW TWO WEEKS FOR DELIVERY**

QUENCHER PLUMBING COMPONENTS

Gaylord Part #	Description	
11383	PRESSURE SWITCH (POTTER)	\$789,30
11465	1" TO 1 1/2" FLOW SWITCH (POTTER)	\$900,58
11466	2" FLOW SWITCH (POTTER)	\$1.515,17
10277	PRESSURE GAUGE TYPE 35 (0-300 PSI)	\$106,43
15856	QUENCHER PRESSURE HOSE ASSEMBLY	\$1.167,38
10171	1" BUTTERFLY VALVE	\$871,24
10172	1-1/4" BUTTERFLY VALVE	\$812,28
10173	1-1/2" BUTTERFLY VALVE	\$974,59
10174	2" BUTTERFLY VALVE	\$5.084,75

QUENCHER CHROME FITTINGS

Gaylord Part #	Description	
15854	1" 45 DEGREE CHROME ELBOW	\$39,63
10551	1" 90 DEGREE CHROME ELBOW	\$39,46
10573	1" CHROME TEE	\$44,37
10582	1" CHROME UNION	\$138,90
10592	1" X 1/2" CHROME BELL REDUCER	\$37,09
10589	1" X 1/2" CHROME REDUCING 90	\$37,09
10651	1" CHROME COUPLER	\$52,84
10642	1" CHROME SLEEVING, 6' STICK	\$476,60

GAS SOLENOID VALVES

Gaylord Part #	Description	
10212	1" GAS SOLENOID VALVE	\$3,075.38
10213	1 ¼" GAS SOLENOID VALVE	\$2,963.63
10214	1 ½" GAS SOLENOID VALVE	\$3,374.40
10215	2" GAS SOLENOID VALVE	\$5,000.00
10211	2 ½" GAS SOLENOID VALVE	\$6,600.21
10210	3" GAS SOLENOID VALVE	\$9,220.00

*** ITEM NOT STOCKED, ALLOW TWO WEEKS FOR DELIVERY**

GAS SOLENOID VALVE REPAIR KITS

Gaylord Part #	Description	
10201	¾" GAS SOLENOID VALVE REPAIR KIT *	\$1,388.64
10204	1 1/4" -1 1/2" GAS SOLENOID VALVE REPAIR KIT *	\$933.92
10205	2" GAS SOLENOID VALVE REPAIR KIT *	\$1,120.71
10206	2 ½" GAS SOLENOID VALVE REPAIR KIT *	\$4,789.81
10207	3" GAS SOLENOID VALVE REPAIR KIT *	\$2,544.96

*** ITEM NOT STOCKED, ALLOW TWO WEEKS FOR DELIVERY**

UTILITY DISTRIBUTION CENTER - UDS COMPONENT PARTS

Gaylord Part #	Description	
70565	GAS RESET BUTTON	\$286.87
76281	EMERGENCY KILL SWITCH	\$155.43
50453	POWER INTERRUPTION DEVICE Includes time delay relay	\$3,489.48

GAS SOLENOID VALVE COILS

Gaylord Part #	Description	
10208	120V COIL FOR ½" & ¾" GAS SOLENOID VALVE*	\$212.68
10219	120V COIL FOR 1" & UP GAS SOLENOID VALVE*	\$810.73

*** ITEM NOT STOCKED, ALLOW TWO WEEKS FOR DELIVERY**

VENTILATOR COMPONENT PARTS

Gaylord Part #	Description	
10905	GREASE CUP 6" X 3 1/4" X 2"	\$40,14
75584	CHROME "T" DOOR HANDLE WITH TONGUE KIT	\$44,27
12301	ELXC WASH DOOR LATCH (Includes PN 12302, Cam)	\$22,16
76072	ELX APRON STYLE GREASE CUP	\$173,79
76040	ELX CAPTURE WALL STYLE GREASE CUP	\$173,79

VENTILATOR, HRU AND RSPC SPRAY NOZZLES

Gaylord Part #	Description	
10303	SINGLE HEAD SPRAY NOZZLE FOR VENTILATORS (PACK OF 1)	\$32,81
10304	DUAL HEAD SPRAY NOZZLE FOR VENTILATORS	\$243,25
10305	HIGH VOLUME SPRAY NOZZLE FOR VENTILATORS*	\$111,40
15330	MIST JET SPRAY NOZZLE FOR CM VENTILATORS*	\$84,67
10306	SPRAY NOZZLE FOR HRU (BRASS)*	\$130,32
10301	SPRAY NOZZLE FOR SPC/RSPC*	\$51,06
19717	RSPC-ESP OCCOLATING WASH NOZZLE	\$38,22
20329	ELXC HIGH VOLUME, WIDE SPRAY EXTRACTOR NOZZLE	\$56,17

VENTILATOR THERMOSTATS

Gaylord Part #	Description	
10102	6" NO THERMOSTAT, 350°	\$873,33
10103	12" NO THERMOSTAT, 350°, FOR CG	\$915,07
16824	6" NC THERMOSTAT, 200°, FOR FX *	\$873,27
18806	6" NC THERMOSTAT, 250°, FOR GX2	\$1.123,04
18465	12" NC THERMOSTAT, 250°, FOR GX2	\$939,99
18781	12" NO COUPLING THERMOSTAT, 250°, FOR CG3 MFG AFTER 7/1/01	\$851,85
18466	15" NC THERMOSTAT, 250°, FOR GX2	\$811,26
18782	15" NO COUPLING THERMOSTAT, 250°, FOR CG3 MFG AFTER 7/1/01 *	\$829,47

*** ITEM NOT STOCKED, ALLOW TEN WEEKS FOR DELIVERY**

VENTILATOR THERMOSTATS

Gaylord Part #	Description	
11928	6" NC THERMOSTAT, 280°, FOR RG AND GX *	\$873,33
11930	6" NC THERMOSTAT, 350°, FOR CG *	\$873,27
15656	12" NO THERMOSTAT, 280°, FOR RG AND GX	\$661,05
15657	12" NO THERMOSTAT, 350°, FOR CG	\$680,91
10104	NAVY FAIL-SAFE THERMOSTAT 2 WIRE, 440V	\$3.143,11
10105	NAVY FAIL-SAFE THERMOSTAT 3 WIRE, 115V OR 220V*	\$3.678,93
19816	NAVY FAIL-SAFE THERMOSTAT 4 WIRE, 440V*	\$4.011,38
11325	NAVY THERMOSTAT MOUNTING PLATE	\$164,53

NO=NORMALLY OPEN CONTACT

NC=NORMALLY CLOSED CONTACT

*** ITEM NOT STOCKED, ALLOW TEN WEEKS FOR DELIVERY**

FUSELINKS

Gaylord Part #	Description	
10321	165° TYPE ML FUSE LINK MA (MAKE UP AIR)	\$26,04
10322	212° TYPE ML FUSE LINK FILTERHOODS	\$29,81
10323	280° TYPE ML FUSE LINK GX OR RG	\$26,04

MI CABLE WITH FITTINGS ATTACHED**PARTS NOT STOCKED. ALLOW 6 WEEKS FOR DELIVERY**

Gaylord Part #	Description	
15812	2 WIRE MI CABLE 24" FROM FITTING TO FITTING	\$546,16
15814	2 WIRE MI CABLE 30" FROM FITTING TO FITTING	\$560,32
15813	2 WIRE MI CABLE 60" FROM FITTING TO FITTING	\$698,43
19191	4 WIRE MI CABLE 24" FROM FITTING TO FITTING	\$568,49
19192	4 WIRE MI CABLE 30" FROM FITTING TO FITTING	\$573,46
19193	4 WIRE MI CABLE 60" FROM FITTING TO FITTING	\$763,00

MI CABLE COMPONENTS

Gaylord Part #	Description	
10106	2 WIRE CONDUCTOR MI CABLE (PRICE/FT.)	\$281,41
15815	4 WIRE CONDUCTOR MI CABLE (PRICE/FT)	\$494,46
10108	2 WIRE TERMINATION KIT (2 FITTINGS) FOR MI CABLE	\$264,37
14943	4 WIRE TERMINATION KIT (2 FITTINGS) FOR MI CABLE	\$365,18
10110	SEALING RING FOR MI CABLE (PACK OF 5)	\$41,20

FIRE SWITCHES

Gaylord Part #	Description	
10100	2 WIRE TOGGLE SWITCH FOR C-1357A	\$63,94
10098	RED FIRE SWITCH – COMMERCIAL OR NAVY, 120V (YELLOW SWITCH DISCONTINUED)	\$668,84
21825	RED FIRE SWITCH – NAVY 440V 6-8 WEEK LEAD-TIME	\$7.397,03
10096	3 WIRE TOGGLE SWITCH (MARINE APPLICATION)	\$92,24
10099	REPLACEMENT GLASS ROD FOR FIRE SWITCH (PACK OF 10)	\$131,69

FAST FOOD VENTILATOR PARTS

Gaylord Part #	Description	
BURGER KING VENTILATORS		
17193	FRYER COMPUTER COVER	\$106,47
90159	BROILER GREASE DRAWER	\$187,68
18249	LEFT HAND BULLET HINGE	\$184,80
18231	RIGHT HAND BULLET HINGE	\$92,40
19009	HEAT SHIELD FRICTION HINGE	\$266,40
WHATABURGER VENTILATORS		
19641	SNAP DISK LIMIT CONTROL	\$166,65
19584	HEATER STRIP	\$297,19

GX EXTRACTOR INSERTS

Determine if you need a GX or GX-DS style. Measure the distance between the handle and the cartridge.

GX will be 5" handle to cartridge, GX-DS will be 7" handle to cartridge.

Gaylord Part #	Description	
12788	GX 16B EXTRACTOR 250/GX-16B	\$567,01
12789	GX 20B EXTRACTOR 250/GX-20B	\$626,09
12790	GX 16B EXTRACTOR FOR DS OR 400 SERIES VENTILATOR/GX-DS-16B	\$636,78
12791	GX 20B EXTRACTOR FOR DS OR 400 SERIES VENTILATOR/GX-DS-20B	\$658,90
92095	GX 16 EXTRACTOR FOR 150 CFM VENTILATOR/GX-16B-150	\$563,62
92090	GX 20 EXTRACTOR FOR 150 CFM VENTILATOR/GX-20B-150	\$580,39
18380	GX2 16 EXTRACTOR/GX2-16	\$675,42
18385	GX2 20 EXTRACTOR/GX2-20	\$777,59
18390	GX2 16 EXTRACTOR FOR DS OR 400 SERIES VENTILATOR – OLD STYLE/GX-DS-16	\$751,22
18395	GX2 20 EXTRACTOR FOR DS OR 400 SERIES VENTILATOR – OLD STYLE/GX-DS-20	\$785,39
18745	GX2 16 EXTRACTOR FOR DS OR 400 SERIES VENTILATOR/GX2-EN-16	\$720,74
18746	GX2 20 EXTRACTOR FOR DS OR 400 SERIES VENTILATOR/GX2-EN-20	\$778,46

GX EXTRACTOR INSERTS

Gaylord Part #	Description	
13215	GX 16A EXTRACTOR - OLD STYLE/GX-16A	\$683,10
13216	GX 20A EXTRACTOR - OLD STYLE/GX-20A	\$739,05
13217	GX 16A EXTRACTOR FOR DS OR 400 SERIES VENTILATOR - OLD STYLE/GX-DS-16A	\$795,94
13218	GX 20A EXTRACTOR FOR DS OR 400 SERIES VENTILATOR - OLD STYLE/GX-DS-20A	\$823,68
75890	GX2-UV-16 EXTRACTOR/GX2-UV-16	\$914,36
75891	GX2-UV-20 EXTRACTOR/GX2-UV-20	\$944,33
75896	GX2-UV-EN-16 EXTRACTOR/GX2-UV-EN-16	\$871,42
75897	GX2-UV-EN-20 EXTRACTOR/GX2-UV-20	\$987,51
18400	GX & GX2 EXTRACTOR REMOVAL TOOL	\$375,48
75587	4" PULL HANDLE KIT FOR GX INSERTS (PACK OF 2)	\$45,15

PG, SG, EL HOOD FILTERS

Gaylord Part #	Description	
18995	10"H X 16"W TYPE 3 S/S GREASE FILTER	\$63,47
18996	10"H X 20"W TYPE 3 S/S GREASE FILTER	\$72,28
18997	12"H X 20"W TYPE 3 S/S GREASE FILTER	\$78,80
18998	16"H X 16"W TYPE 3 S/S GREASE FILTER	\$73,02
18999	16"H X 20"W TYPE 3 S/S GREASE FILTER	\$88,61
19000	20"H X 16"W TYPE 3 S/S GREASE FILTER	\$91,63
19001	20"H X 20"W TYPE 3 S/S GREASE FILTER	\$98,83
19002	25"H X 16"W TYPE 3 S/S GREASE FILTER	\$95,20
19003	25"H X 20"W TYPE 3 S/S GREASE FILTER	\$114,63
19875	12"H X 16"W TYPE 3 S/S GREASE FILTER	\$71,82

PG, SG, EL STAINLESS STEEL FILTERS WITH SPARK ARRESTER

Gaylord Part #	Description	
18897	16"H X 20" W TYPE 1 S/S GREASE FILTER W/SPARK ARRESTER	\$646,60
18898	16"H X 16" W TYPE 1 S/S GREASE FILTER W/SPARK ARRESTER	\$704,19

XG EXTRACTOR CARTIDGES

Gaylord Part #	Description	
75964	11Hx16W XG EXTRACTOR FOR BURGER KING VENTILATORS	\$623,69

XGS EXTRACTOR CARTIDGES

76044	11" XGS EXTRACTOR (STANDARD)	\$159,20
76042	18" XGS EXTRACTOR (ENLARGED)	\$269,84
76046	XGS EXTRACTOR REMOVAL TOOL	\$413,81

Gaylord Part # Description

50432	2 FT RECESSED LIGHT COMPLETE (FLUORESCENT)	\$882,49
19681	3 FT RECESSED LIGHT COMPLETE (FLUORESCENT)	\$716,21
19651	4 FT RECESSED LIGHT COMPLETE (FLUORESCENT)	\$773,73
20340	2 FT RECESSED LIGHT COMPLETE (LED)	\$1,373,96
20341	3 FT RECESSED LIGHT COMPLETE (LED)	\$1,842,25
20342	4 FT RECESSED LIGHT COMPLETE (LED)	\$1,919,82
13211	12 X 12 LIGHT LENS AND RETAINER	\$221,16
22514	2 FT LIGHT LENS AND RETAINER	\$247,26
10111	3 FT LIGHT LENS AND RETAINER	\$242,20
10112	4 FT LIGHT LENS AND RETAINER	\$359,70
19623	12X12 RECESSED LIGHT COMPLETE (INCANDESCENT)	\$561,05
23362	RECESSED FLUORESCENT HARDWARE KIT (INCLUDES 4 SCREWS, CAGE NUT, AND O'RING)	\$17,74

HOOD LIGHTS**PARTS NOT STOCKED. LEAD TIME WILL VARY SPECIAL PRICING AVAILABLE FOR BULK ORDERS****Gaylord Part # Description**

22886	LED PUCK LIGHT	\$755,50
22888	LED PUCK LIGHT 220 VOLT	\$827,68
22887	LED PUCK LIGHT BASE	\$176,01
10119	GLOBE FOR BULLET SHAPED 100 WATT LIGHT FIXTURE	\$48,47
10120	LIGHT HOUSING FOR 100 WATT LIGHT	\$59,48
11124	WIRE GUARD FOR 100 WATT LIGHT GLOBE	\$30,71
10121	CLEAR GLOBE FOR CONE SHAPED FIXTURE (RIBBED)	\$273,33
10126	BALLAST FOR FLUORESCENT FIXTURE (DOES NOT INCLUDE SOCKETS)	\$247,54
NO DISCOUNT APPLIES ON LED LIGHT TUBES		
20614	4' LED LIGHT TUBE	\$562,10
20613	3' LED LIGHT TUBE	\$489,87
20612	2' LED LIGHT TUBE	\$378,11
23987	3' LED RECESSED WARM WHITE LED STRIP LIGHT	\$1,150,83
23988	4' LED RECESSED WARM WHITE LED STRIP LIGHT	\$1,377,23
23990	12"x12" LED RETRO-FIT FOR INCANDESCENT FIXTURES NATURAL WHITE	\$811,79
23991	12"x12" LED RETRO-FIT FOR INCANDESCENT FIXTURES NATURAL WARM	\$811,79

RSPC-TPF/ESP AND SPC COMPONENT PARTS

Gaylord Part #	Description	
19547	RSPC POWER PACK DOOR LATCH, SQUARE	\$114,98
19548	RSPC DOOR LATCH KEY (SQUARE)	\$21,07
76131	24" HORIZONTAL OUTER CELL FOR RSPC *	\$6.525,60
76132	24" HORIZONTAL INNER CELL FOR RSPC*	\$6.759,53
12801	SOAK TANK FOR 24" CELL *	\$2.098,25
16514	RSPC 3-4 CELL POWER SUPPLY (4 CELLS)	\$2.979,50
20605	18 GA HIGH VOLTAGE CABLE (PER FOOT)	\$10,59
10332	TERMINAL CLIP COVER FOR CELLS, 90° RUBBER BOOT	\$22,28
10335	SPARK PLUG, TERMINAL (10 PER PACK)	\$31,99
10338	IONIZING WIRE TYPE C	\$49,98
11301	DOUBLE CELL SPRING CONNECTOR (5 PER PACK)	\$114,54
18785	RSPC METER RETRO FIT	\$127,23
19041	DOOR PLUNGER SAFETY SWITCH FOR SPC	\$506,13
12798	DOOR PLUNGER SAFETY SWITCH RSPC	\$506,13
22417	ESP INSULATOR PAD	\$32,89
19700	OSOLATING WASH MOTOR (RSPC)	\$1.322,12
19716	1/2" SWIVEL ELBOW	\$551,76
19715	1/2" LIVE SWIVEL STRAIGHT	\$513,79

RSPC-TPF FILTERS**Contact Service Agent**

Gaylord Part #	Description	
30074	24X24X4 CLI PLEATED PRE-FILTER (TPF)	\$322,04
30241	24X24X22 6 POCKET 95% BAG FILTER (TPF) **(30514 REPLACEMENT)**	\$287,76
30515	DOP 95% FILTER 24X24X12 FINAL FILTER (TPF)	\$1.250,00

ESP FILTERS**Contact Service Agent**

Gaylord Part #	Description	
30167	DEBRIS SCREEN 24X24X2	\$193,57
20006	XGS IMPACTOR 24"x24"x2"	\$662,02
30080	MOISTURE SEPARATOR 24X24X4	\$818,74

ODOR CONTROL FILTERS**Contact Service Agent**

Gaylord Part #	Description	
30905	SINGLE PASS ODOR 24X6X18 (replaces part number 30643)	\$760,20
30906	SINGLE PASS ODOR REPLACEMENT PANELS (PACK OF 2)	\$531,08
30913	MEDIA TESTER	\$166,86

RSPC FM-100 MONITORING PANEL PARTS

Gaylord Part #	Description	
19038	CLEAN AIR FM-100 CONTROL LABEL	\$122,84
19317	INDICATOR LIGHT - GREEN	\$24,44
18178	CLEAR NEON INDICATOR LIGHT 125V (PACK OF 2)	\$33,65
19318	INDICATOR LIGHT - RED	\$16,62
11119	LIFT & TURN COMPRESSION LATCH	\$233,78
19076	FM-100 CANCEL SWITCH	\$294,68
18644	C-150 SWITCH LABEL	\$22,94
19154	LOW ODOR CONTROL CHEM. LABEL	\$122,95
17061	FUSE - MAIN	\$19,12
11403	CONTROL RELAYCR1	\$142,53
11418	SOCKET CR1	\$66,38
10283	CONTROL RELAY R3	\$75,44
10295	SOCKET CR3	\$42,47
11399	CONTROL RELAY CR4	\$63,36
11413	SOCKET CR4	\$45,62
30375	TIMING RELAY ON DELAY DPT TR1	\$424,96
19272	SOCKET 8-PIN	\$33,51
19319	SONALERT	\$229,17

RSPC FM-1000 MONITORING STATION PARTS

20111	FM-1000 OPERATOR INTERFACE WITH PROGRAM	\$2,021,01
20110	FM-1000 PLC WITH PROGRAM	\$2,003,43
20107	FM-1000 CABLE	\$166,95

ODOR CONTROL PARTS (SPRAY TYPE) Parts not stocked. Lead time will vary

Gaylord Part #	Description	
19119	SPRAY ODOR CABINET ASSEMBLY (25"X25")	\$11,447,71
10272	1/4" I.D. FLEXIBLE SUCTION TUBE SOLD PER FOOT	\$3,21
19065	SPRAY NOZZLE ASSEMBLY	\$2,859,69
11000	3/8" COPPER TUBING	\$19,12
19073	CYCLE AND SPRAY TIMER RELAY	\$531,96
10276	PRESSURE GAUGE	\$95,30
19070	NEEDLE VALVE	\$250,50
19072	AIR COMPRESSOR	\$2,160,73
19075	HEATER	\$2,001,91
19097	5 GALLON CONTAINER OF GS-710	\$79,22
19071	LEVEL SENSOR FOR SPRAY ODOR CHEMICAL	\$819,20
10269	1/4" FOOT VALVE (IN TANK)	\$70,64

MYLAR FACEPLATE LABELS

Gaylord Part #	Description	
18899	C-6000 MYLAR FACEPLATE	\$127,75
16907	C-5000 MYLAR FACEPLATE	\$186,10
13181	MODEL QUA SERIES MYLAR FACEPLATE (VERTICAL)	\$114,93
13124	MODEL QUS SERIES MYLAR FACEPLATE (HORIZONTAL)	\$114,93
15118	¼" X 7/8" OD PORON DISC W/ PSA (PACK OF 2) (REQUIRED WHEN REPLACING MYLAR FACEPLATE)	\$37,75

EXHAUST DAMPERS

ALLOW 6-8 WEEKS FOR FABRICATION

Gaylord Part #	Description	
12732	AUXILIARY EXHAUST TERMINAL 440V*	\$8.341,23
12749	AUXILIARY EXHAUST TERMINAL 115V*	\$8.341,23
18826	AUXILIARY EXHAUST TERMINAL DE-SMOKE 440V*	\$8.115,31
18825	AUXILIARY EXHAUST TERMINAL DE-SMOKE 115V*	\$8.115,31
12828	REPAIR KIT FOR DE-SMOKE STATION	\$1.184,96
76001	GED DIVERTING DAMPER	\$9.181,28
12828	REPAIR KIT FOR DE-SMOKE STATION	\$1.184,96

*SPECIFY HEIGHT, WIDTH AND THE DAMPER LOCATION USE APPENDIX SHEET A-18 FOR ORDERING.

GAYLORD WASH CLEANERS

Gaylord Part #	Description	
23405	GL-GS710E-5	\$112,50
30480	GL-G510EF-30	\$764,00
23398	GL-G710E-55	\$1.930,00
19793	GL-G510EF-2.5x2	\$142,00
30479	GL-G510EF-5	\$124,00
23397	GL-G710E-30	\$1.396,00
30481	GL-G510EF-55	\$998,00
30478	GL-G510EF-1x4	\$114,00
23405	GL-G710E-TH5	\$163,77

Appendix A-18

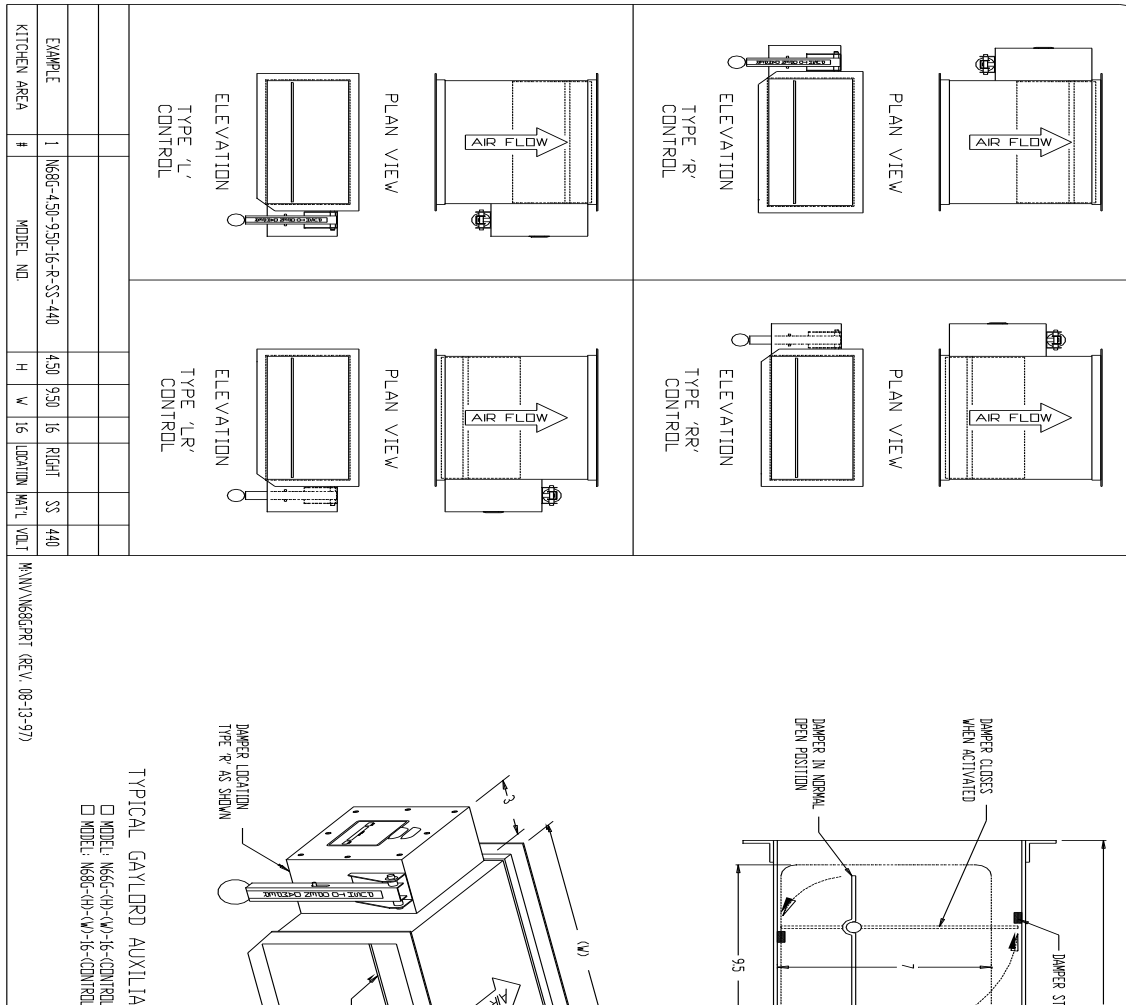

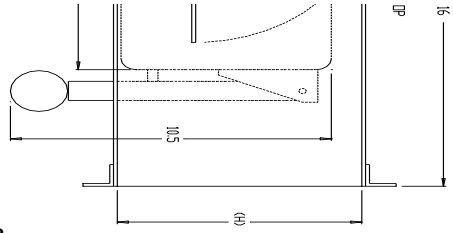

Appendix A-18

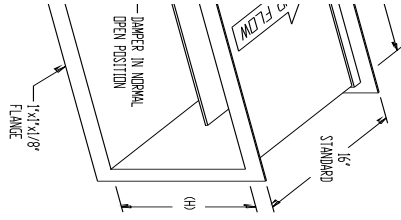

RY EXHAUST TERMINAL
 . LOCATION-MATERIAL-120V
 . LOCATION-MATERIAL-400V

Appendix A-18

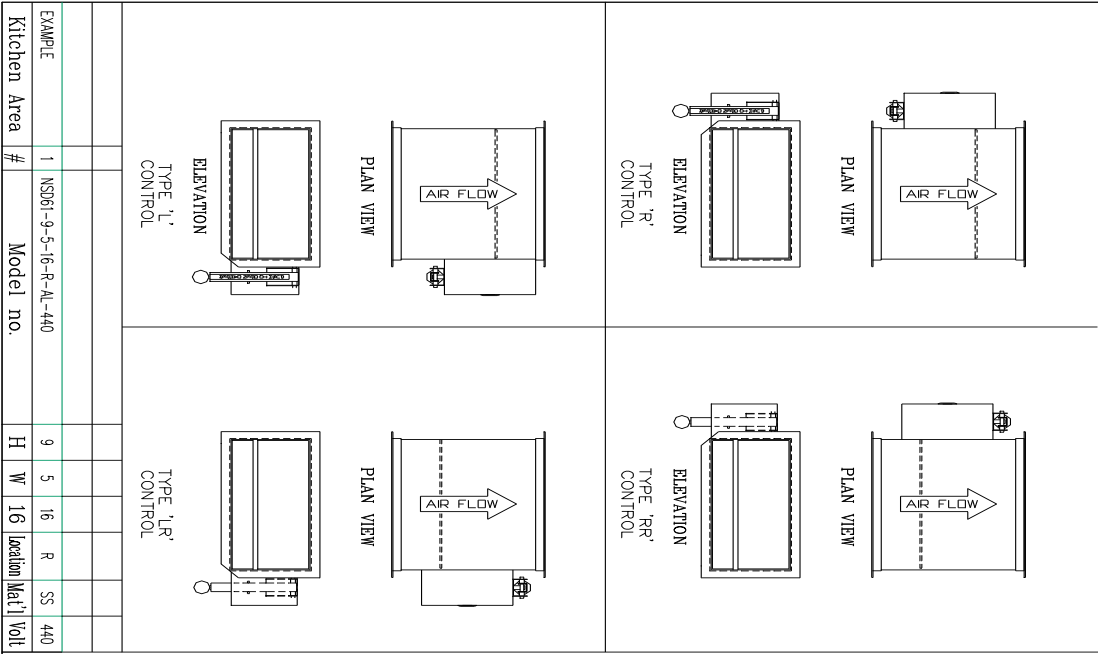

EXAMPLE	1	NSD61-9-5-16-R-AL-440	9	5	16	R	SS	440
Kitchen Area #		Model no.	H	W	L	Location	Mat'l	Volt

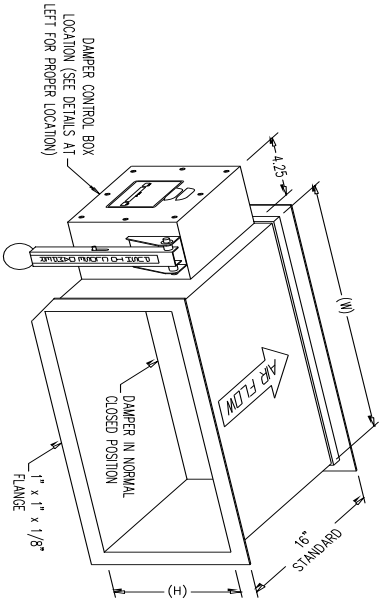
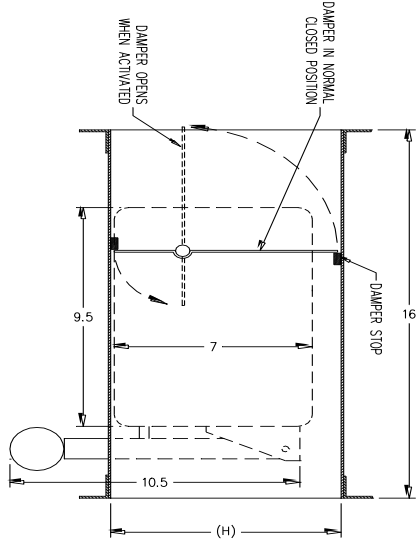

TYPICAL GAYLORD AUXILIARY EXHAUST DE-SMOKE TERMINAL WITH SOLENOID OPERATED DAMPER
 MODEL: NSD61-(H)-(W)-16-(CONTROL LOCATION)-(MATERIAL)-VOLTAGE

**DETERGENT PUMP
MODEL NUMBER VF-100P-60B**

ITEM.	PART NUMBER	ITEM.	PART NUMBER
MOTOR COVER.....	10226	YOKE AND BEARING ASSEMBLY.....	10237
ELECTRICAL "J" BOX.....	N/A	PUSH BUTTON TEST SWITCH.....	10238
COVER MOUNTING SCREWS.....	N/A	CAM #1.....	10254
MOTOR MOUNTING SCREWS.....	N/A	CAM #2.....	10255
ARMATURE BEARING.....	10231	CAM #3.....	10256
COIL (115 VOLT).....	10232	CAM #4.....	10257
COIL (220 VOLT).....	10259	SCREWS FOUR REQUIRED.....	10239
ARMATURE.....	10233	DIAPHRAGM.....	10240
ARMATURE SPACER.....	10234	BRASS OUTLET.....	10242
GEAR BOX ASSEMBLY.....	10253	*TOP CAP.....	10244
BRACKET.....	10236	SPRING.....	10246
SET SCREW.....	10237	PUMP HEAD (Complete with all fittings).....	10247

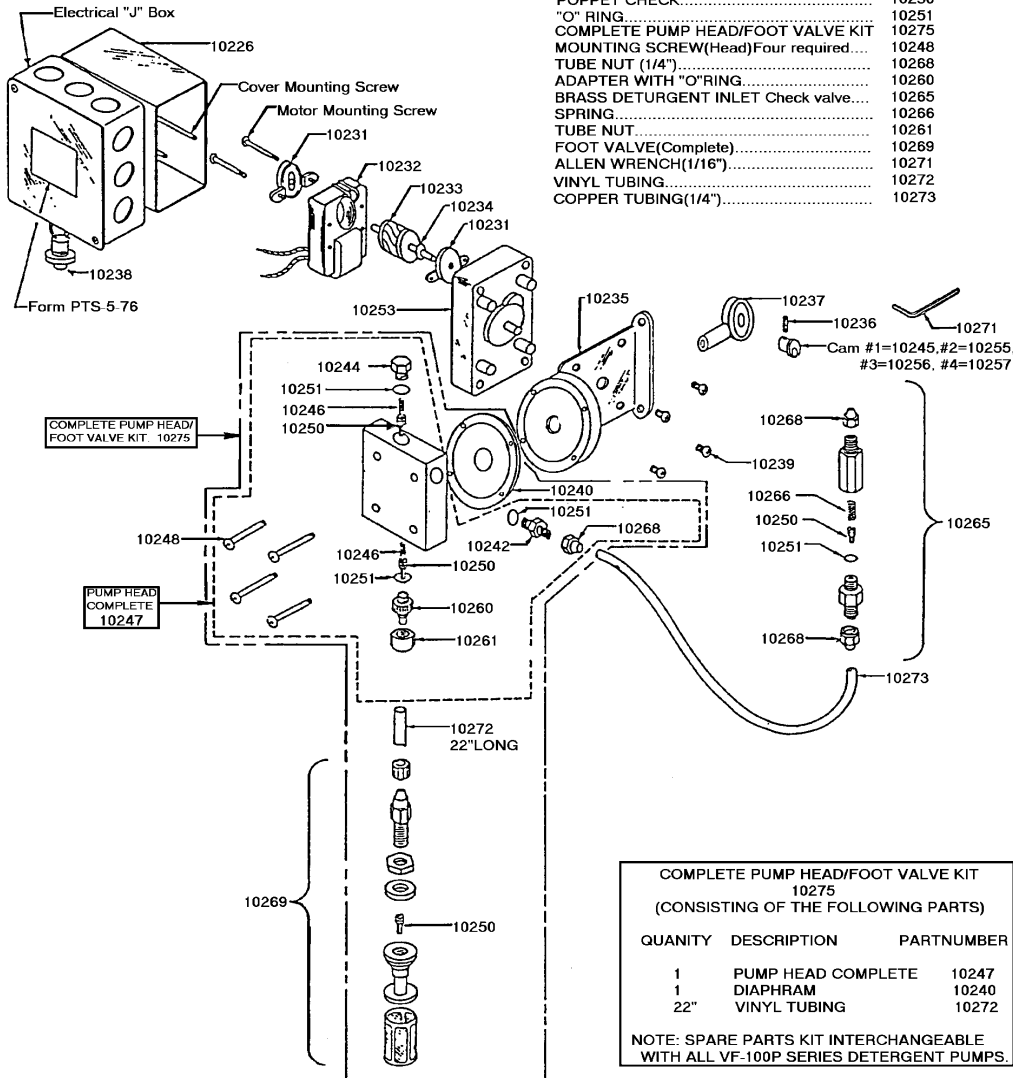

COMPLETE PUMP HEAD/FOOT VALVE KIT 10275 (CONSISTING OF THE FOLLOWING PARTS)		
QUANTITY	DESCRIPTION	PARTNUMBER
1	PUMP HEAD COMPLETE	10247
1	DIAPHRAM	10240
22"	VINYL TUBING	10272

NOTE: SPARE PARTS KIT INTERCHANGEABLE WITH ALL VF-100P SERIES DETERGENT PUMPS.



GAYLORD INDUSTRIES, INC.

WORLD HEADQUARTERS: P.O. BOX 1149 • TUALATIN, OR 97062-1149 USA
PHONE: (503) 691-2010 (800) 547-9696 • FAX: (503) 692-6048

GX EXTRACTOR IDENTIFICATION SHEET

- 1- Measure and fill in the measurement for the height of the extractor opening.
- 2- Measure and fill in the measurement for the depth of the extractor.
- 3- Measure the length-wise cartridge opening _____.
- 4- Indicate whether extractor has clip style "A" or "B".
- 5- Approximate year the hood was built _____.

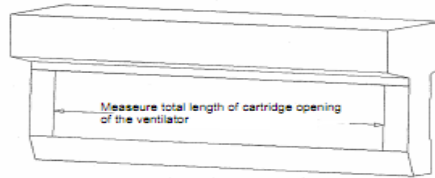
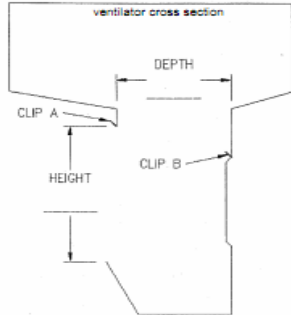

Depth = 7" = GX-400 or GX-400-DS
 Depth = 5" = GX-250
 Depth = 3" = GX-150

Height = 7 1/2" = GX-250
 Height = 10" = GX or GX-DS

Clip "A" = "A" style cartridge
 Clip "B" = "B" style cartridge

Shipping Information:

Address: _____

Phone No.: _____

Payment Terms:

COD Pre Pay VISA / MASTERCARD